

# SL60

Linear stem actuator  
Thrust force 600N  
Max. stroke 750mm



## DESCRIPTION FOR TECHNICAL SPECIFICATIONS

Linear electric actuator Topp model SL60 with self-aligning tilting movement, complete with support and fitting accessory for top hung windows. Operation at 230V 50Hz, or, as an alternative, at 24V DC. Max. traction and thrust force 600N. Preset for the connection in parallel of two or more actuators, with stroke end microswitches. Available strokes: 180 - 230 - 350 - 550 - 750 mm. CE marked device.



## TECHNICAL CHARACTERISTICS

	SL60 230V	SL60 24V
Power supply voltage	230V ~ 50Hz	24V DC
Maximum applicable load in thrust	600 N	
Maximum applicable load in traction	450 N	500 N
Stroke	180 - 230 - 350 - 550 - 750 mm	
Absorbed current	0,33 A	1,5 A
Idle translation speed	12 mm/s	7 mm/s
Duration of the idle stroke	(stroke/idle translation speed)	
Double electrical insulation	YES	-
Service Type	S2 of 3 min	
Operating temperature	- 5°C + 50°C	
Protection degree of electrical devices	IP 55	
Parallel connection of 2 or more actuators	YES	
Stroke end	micro switch	
Dimensions	from 337 up to 907x47x104 mm	

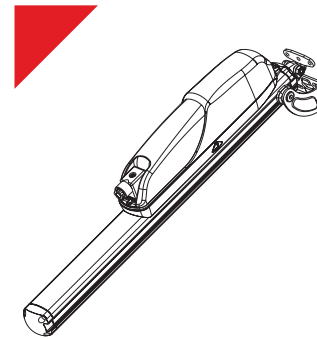

## CODE PRODUCT DESCRIPTION

### SL60 standard 1 push point

3B1#	SL60 linear stem actuator 230V stroke 180 mm
3B1#	SL60 linear stem actuator 230V stroke 180 mm (louvers)
3B1#	SL60 linear stem actuator 230V stroke 230 mm
3B1#	SL60 linear stem actuator 230V stroke 350 mm
3B1#	SL60 linear stem actuator 230V stroke 550 mm
3B1#	SL60 linear stem actuator 230V stroke 750 mm
3B1#	SL60 linear stem actuator 24V stroke 180 mm
3B1#	SL60 linear stem actuator 24V stroke 180 mm (louvers)
3B1#	SL60 linear stem actuator 24V stroke 230 mm
3B1#	SL60 linear stem actuator 24V stroke 350 mm
3B1#	SL60 linear stem actuator 24V stroke 550 mm
3B1#	SL60 linear stem actuator 24V stroke 750 mm

### Description of the standard pattern

3B1#	SL60 linear stem actuator 230V stroke 350 mm
	Actuator supporting bracket
	Fitting bracket to the frame
	Spare parts

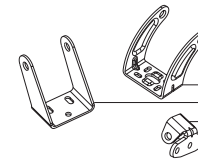

### Accessories and spare parts

1B1580	Stroke restrictor kit
1B1813	Actuator supporting bracket
1S1603	Actuator supporting bracket for louvers
1S1604	Fitting bracket to the frame
3B1001	Spare parts
3B1002	Spare parts for louvers

Special strokes available

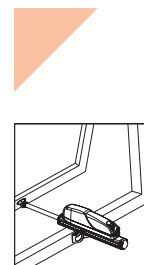

Top-hung windows

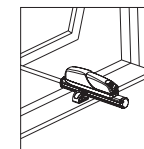

Top-hung windows

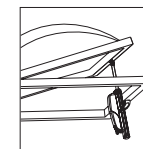

Cupolas

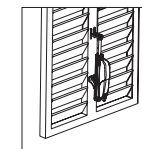

Louvers

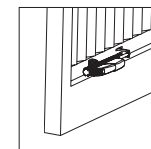

Louvers